



TIPO TYPE	POTENZA NOMINALE NOMINAL POWER		POTENZA ASSORBITA INPUT POWER	AMPERE	Q = PORTATA - CAPACITY													
	P2		P1		Trifase Three-phase	m <sup>3</sup> /h	6	12	18	24	30	36	42	48	54	60	66	
Trifase Three-phase	HP	kW	kW	Trifase Three-phase		lt/1'	100	200	300	400	500	600	700	800	900	1000	1100	
					Prevalenza manometrica totale in m.C.A. - Total head in meters w.c.													
CX 40-125/2,2	3	2,2	2,8	5,1	H (m)	21,5	21,1	20,5	19,5	18	16							
CX 40-125/3	4	3	3,7	6		26,5	26,1	25,5	24,5	23,5	22	20						
CX 40-160/4	5,5	4	5,4	8,5		32	31	30	28,8	28	27	26	23					
CX 40-200/5,5	7,5	5,5	7,7	12,4		43	42,5	41,8	41	40	39	37,8	36,5	35				
CX 40-200/7,5	10	7,5	10,5	16,5		53,5	52,8	52,1	51,5	50,5	49,5	48,5	47	45	43			
CX 40-200/11	15	11	15	23,6		65	64,8	64,6	64,4	63,5	62,5	61	59	57	55	53		

TIPO TYPE	POTENZA NOMINALE NOMINAL POWER		POTENZA ASSORBITA INPUT POWER	AMPERE	Q = PORTATA - CAPACITY												
	P2		P1		Trifase Three-phase	m <sup>3</sup> /h	6	12	18	30	36	42	54	60	66	72	78
Trifase Three-phase	HP	kW	kW	Trifase Three-phase		lt/1'	100	200	300	500	600	700	900	1000	1100	1200	1300
					Prevalenza manometrica totale in m.C.A. - Total head in meters w.c.												
CX 50-125/4	5,5	4	4,8	7,5	H (m)	27	26,8	26,6	25,5	24,5	23,5	21	19	17			
CX 50-200/7,5	10	7,5	8,8	14,2		40,5	40,4	40,2	39,3	38,5	37	34	32,5	31	29		
CX 50-200/11	15	11	14	22,2		55	54,8	54,6	53,8	52,8	51,5	48,5	47	44	38		
CX 50-200/15	20	15	17	27			62	61,8	61,5	61,2	60,4	58	56,5	53	50		
CX 50-200/18,5	25	18,5	21	33			70,5	70,3	70	69,8	69	67	65,5	64	62	60	

TIPO TYPE	POTENZA NOMINALE NOMINAL POWER		POTENZA ASSORBITA INPUT POWER	AMPERE	Q = PORTATA - CAPACITY											
	P2		P1		Trifase Three-phase	m <sup>3</sup> /h	24	36	48	60	72	84	96	108	120	132
Trifase Three-phase	HP	kW	kW	Trifase Three-phase		lt/1'	400	600	800	1000	1200	1400	1600	1800	2000	2200
					Prevalenza manometrica totale in m.C.A. - Total head in meters w.c.											
CX 65-125/7,5	10	7,5	8,3	13,3	H (m)	26,5	26	25,4	24,5	23,3	21,5	20	18	15,5		
CX 65-160/11	15	11	12,7	20,5		35	34,5	33,5	32,5	31,5	30	28,5	26,5	24,5	22	
CX 65-160/15	20	15	16,5	26,2		42,5	42,2	41,8	41	39,8	38,2	37	35,5	34	31	
CX 65-200/18,5	25	18,5	21	33		52	51,5	50,5	49,5	48,5	47,5	46	44,5	42,5	39,5	35,5

TIPO TYPE	POTENZA NOMINALE NOMINAL POWER		POTENZA ASSORBITA INPUT POWER	AMPERE	Q = PORTATA - CAPACITY											
	P2		P1		Trifase Three-phase	m <sup>3</sup> /h	60	72	84	108	132	156	168	180	195	210
Trifase Three-phase	HP	kW	kW	Trifase Three-phase		lt/1'	1000	1200	1400	1800	2200	2600	2800	3000	3250	3500
					Prevalenza manometrica totale in m.C.A. - Total head in meters w.c.											
CX 80-160/11	15	11	12	19	H (m)	26	25,5	25	22,8	20	17	15,5	14	11		
CX 80-160/15	20	15	16	26		33	32,5	31	29,5	27	24	22,5	21	18,5	15,5	
CX 80-160/18,5	25	18,5	20	32		37,5	37,2	36,8	35	33	30,5	29	27	25	22	
CX 80-200/22	30	22,5	25	39		43,5	43	42,5	41	39	36	34,5	33	30,5	27	23,5



# ELETTROPOMPE CENTRIFUGHE MONOBLOCCO INOX

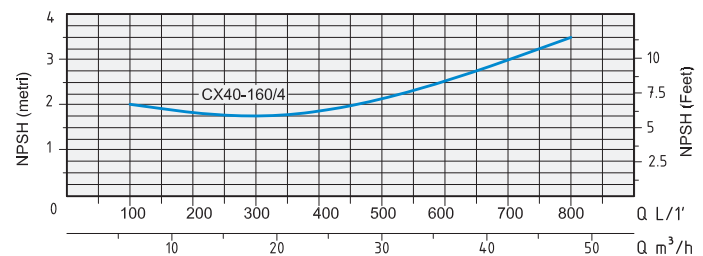
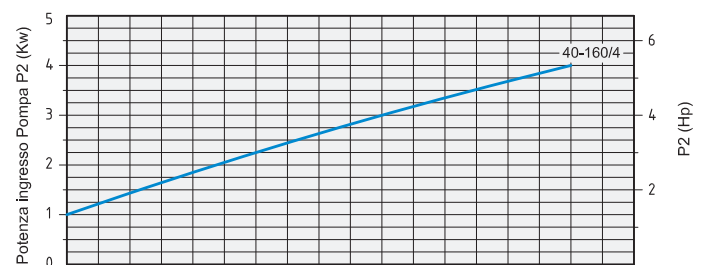
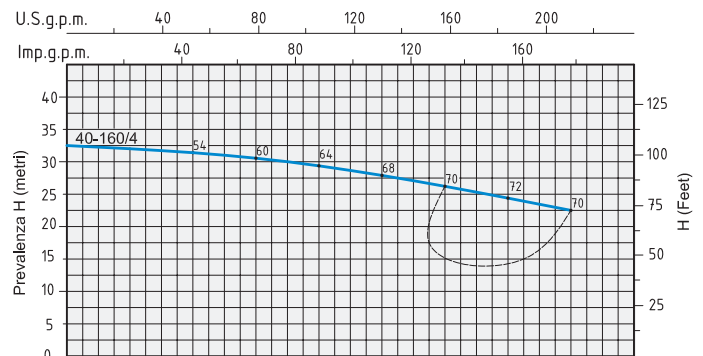
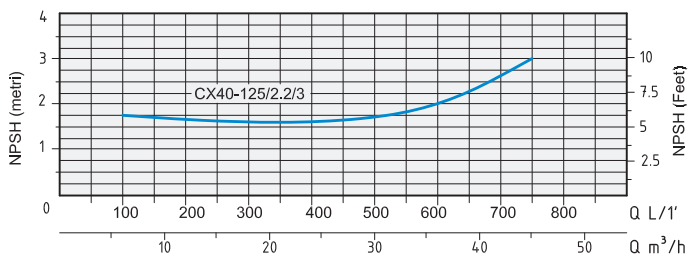
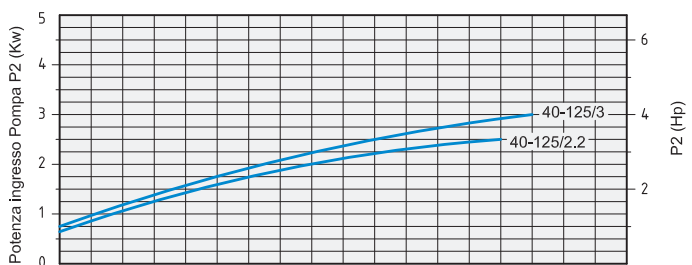
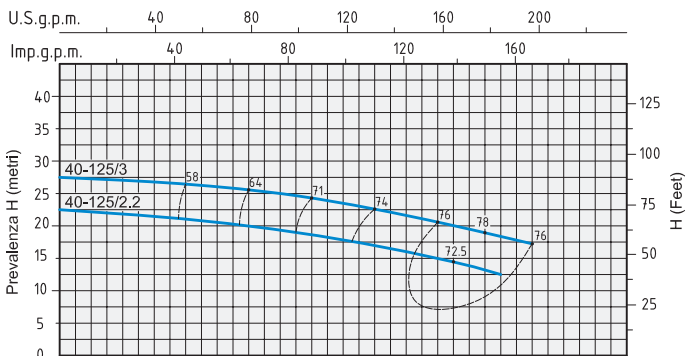
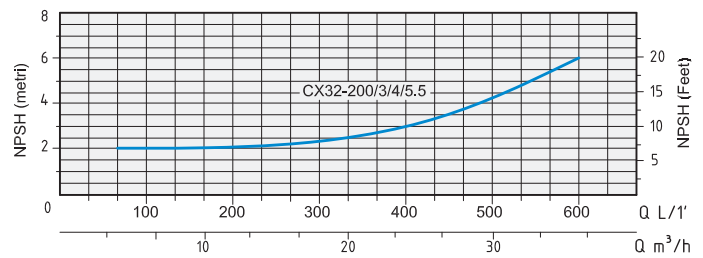
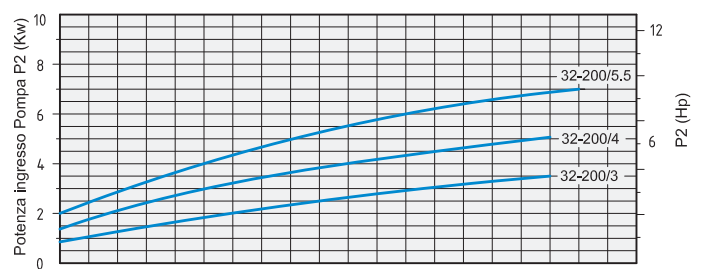
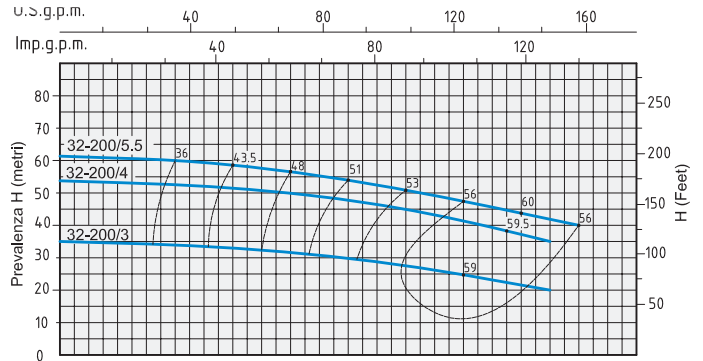
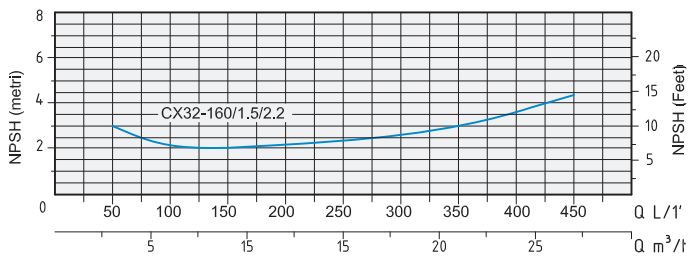
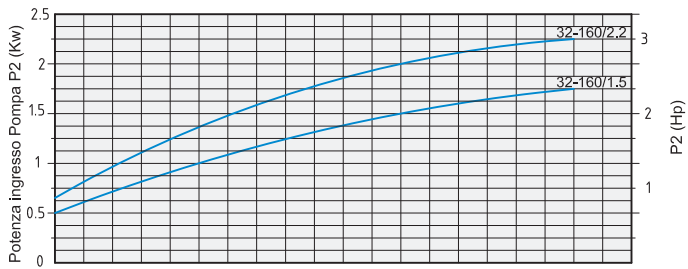
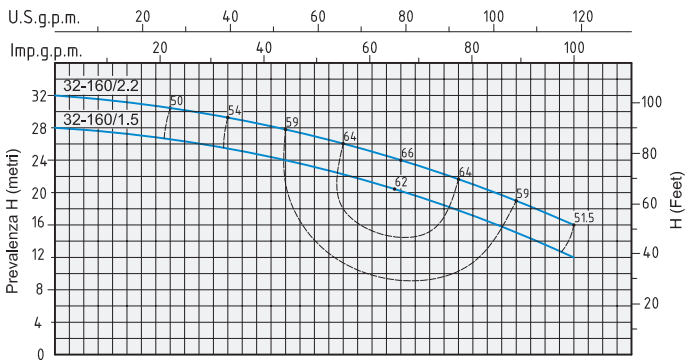

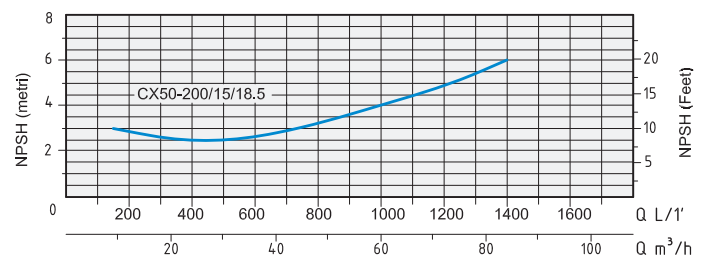
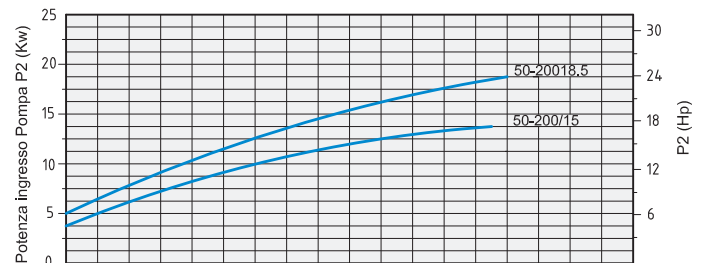
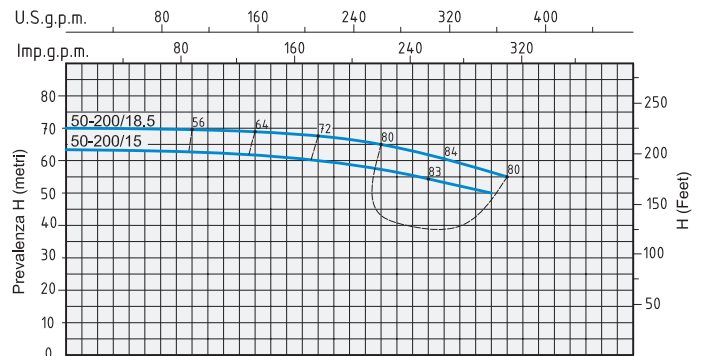
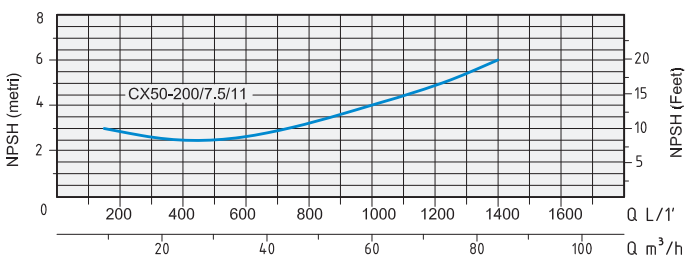
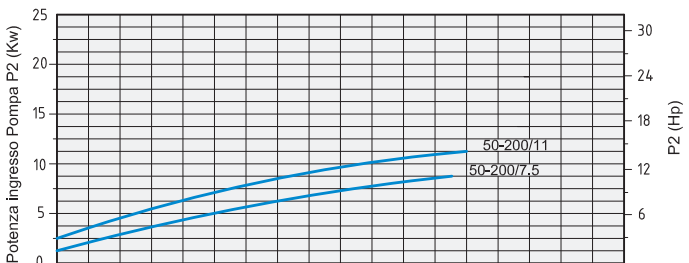
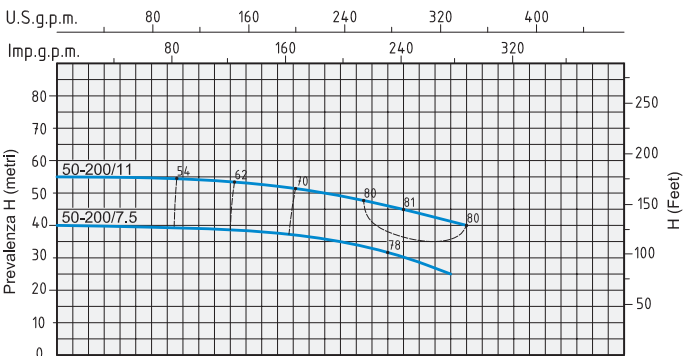
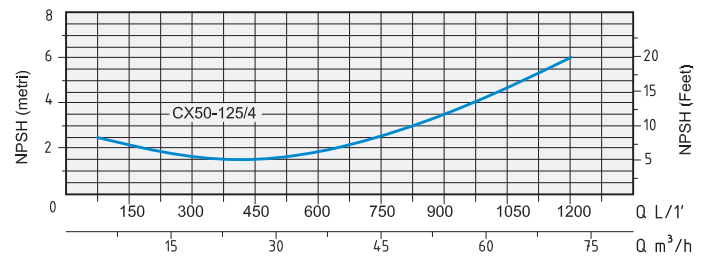
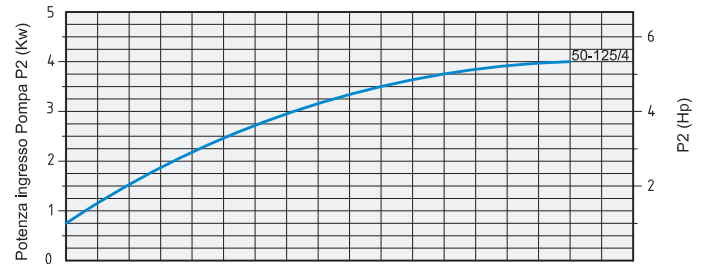
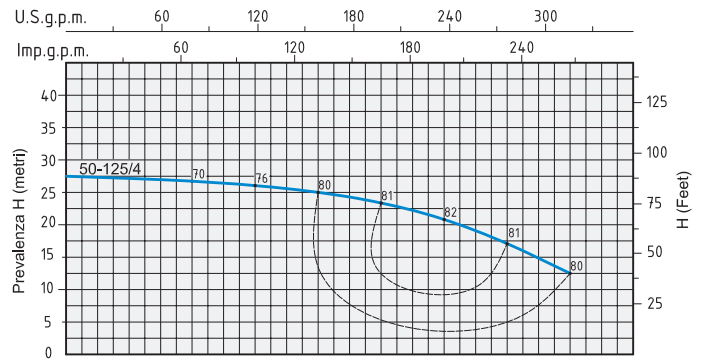
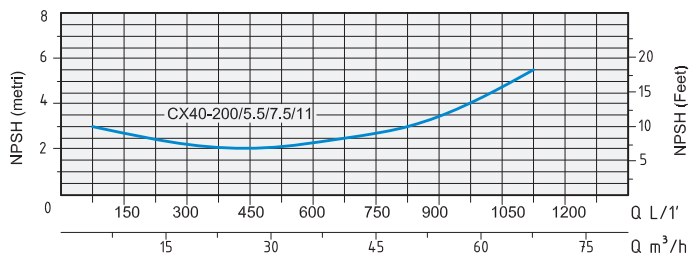
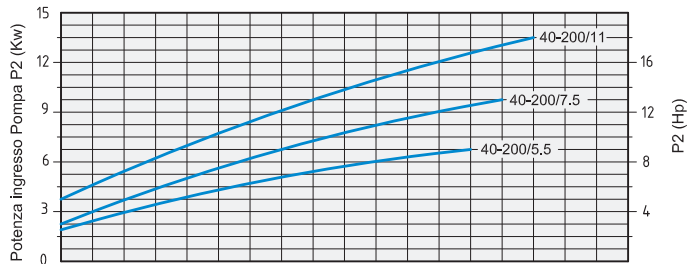
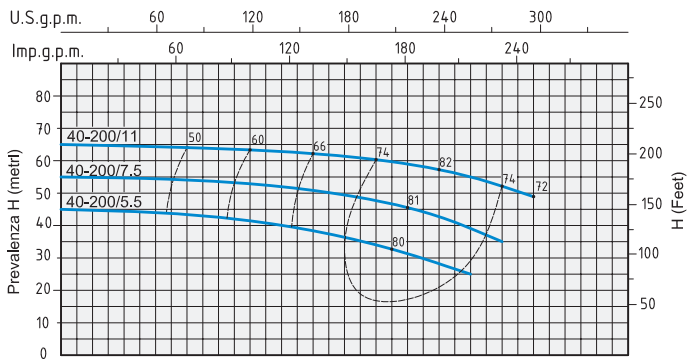

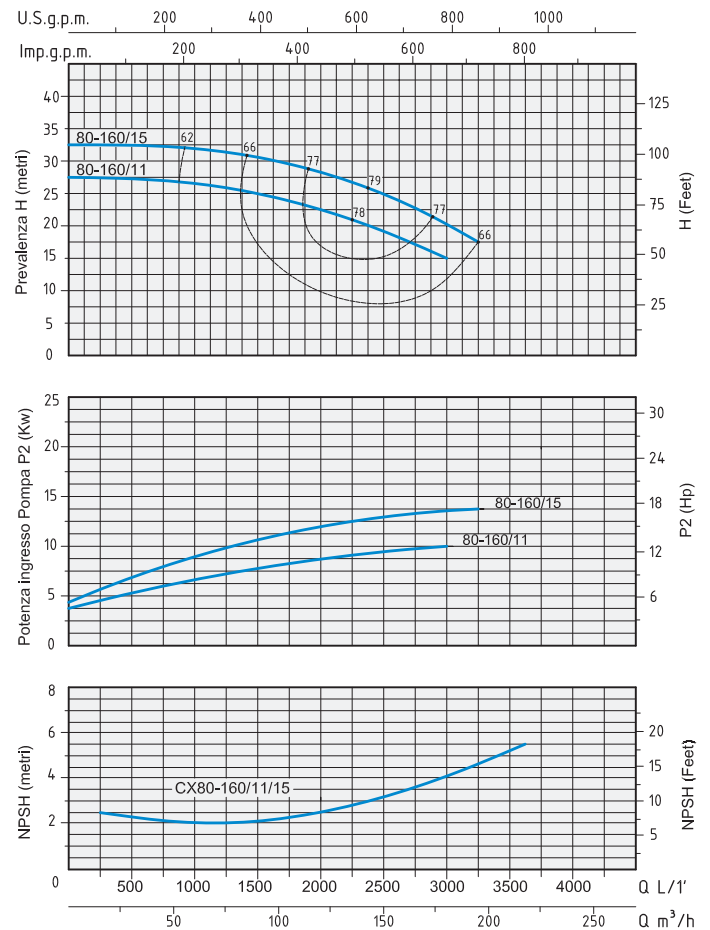
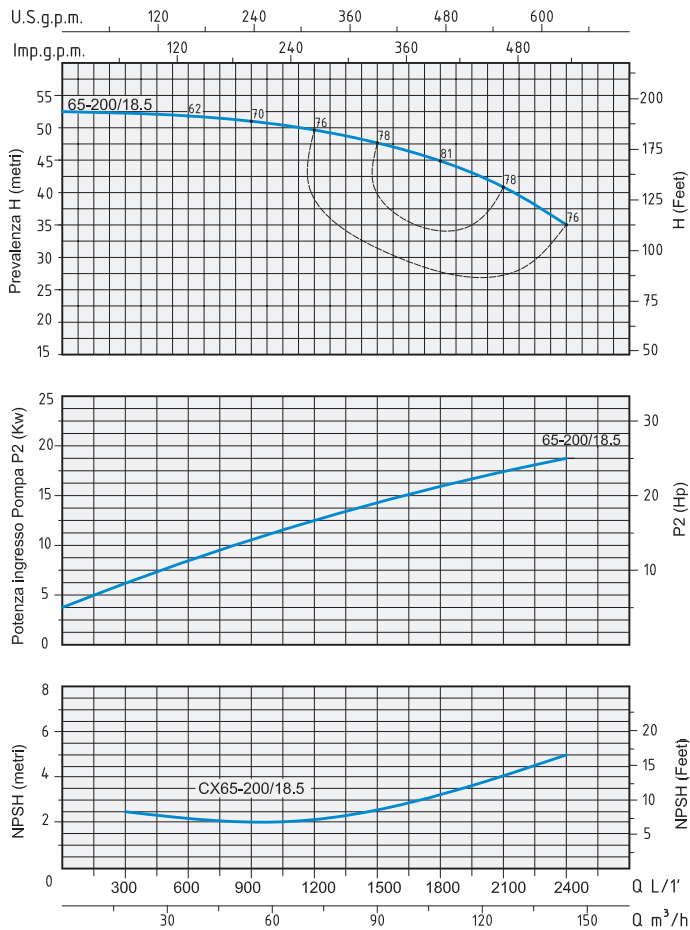
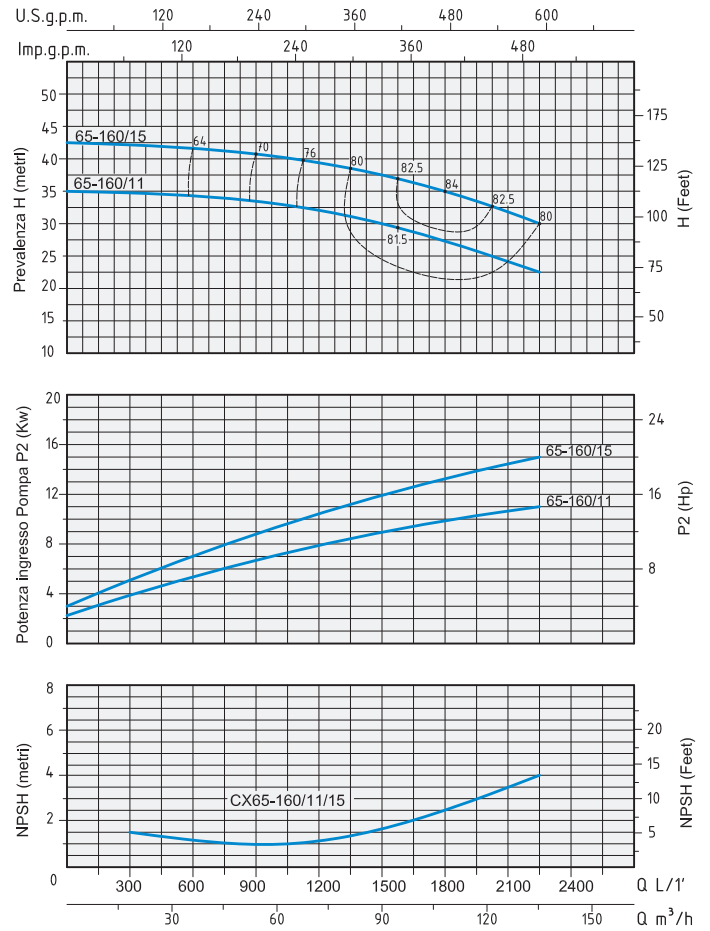
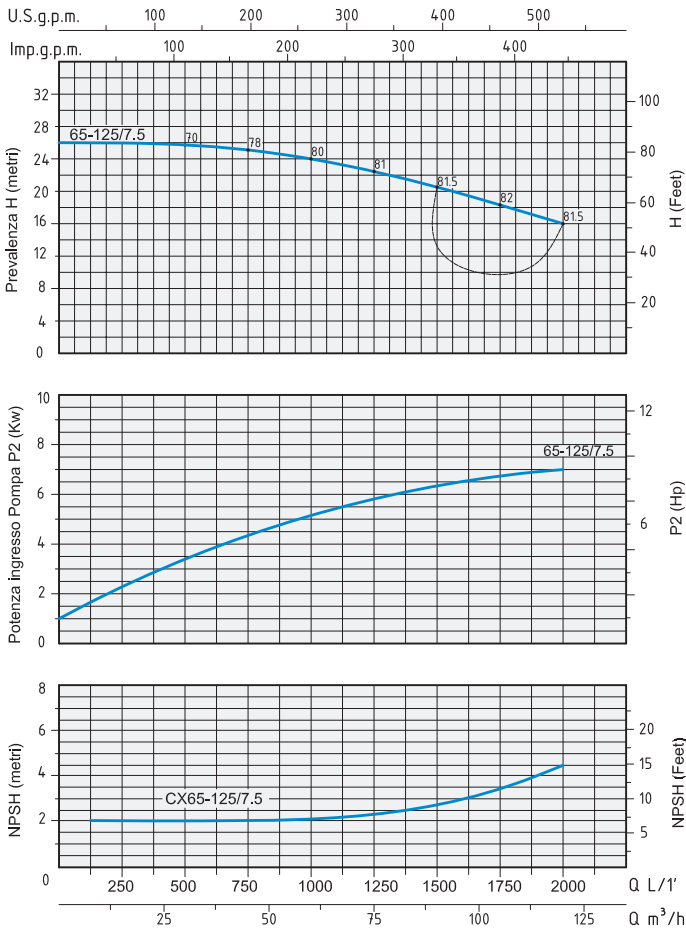

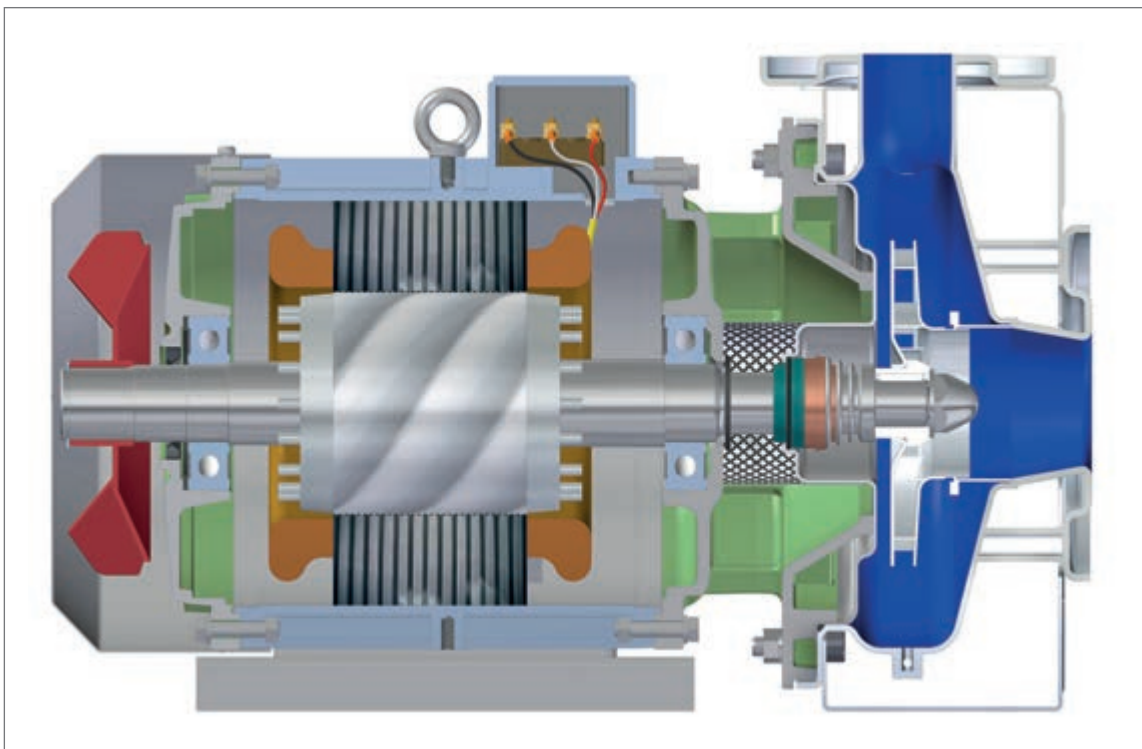
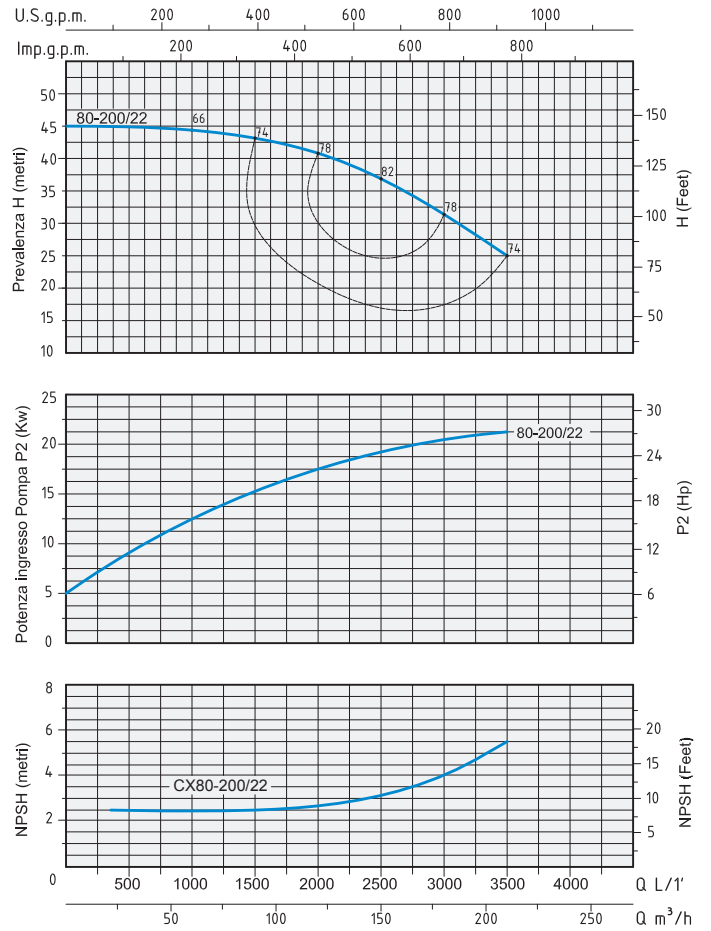
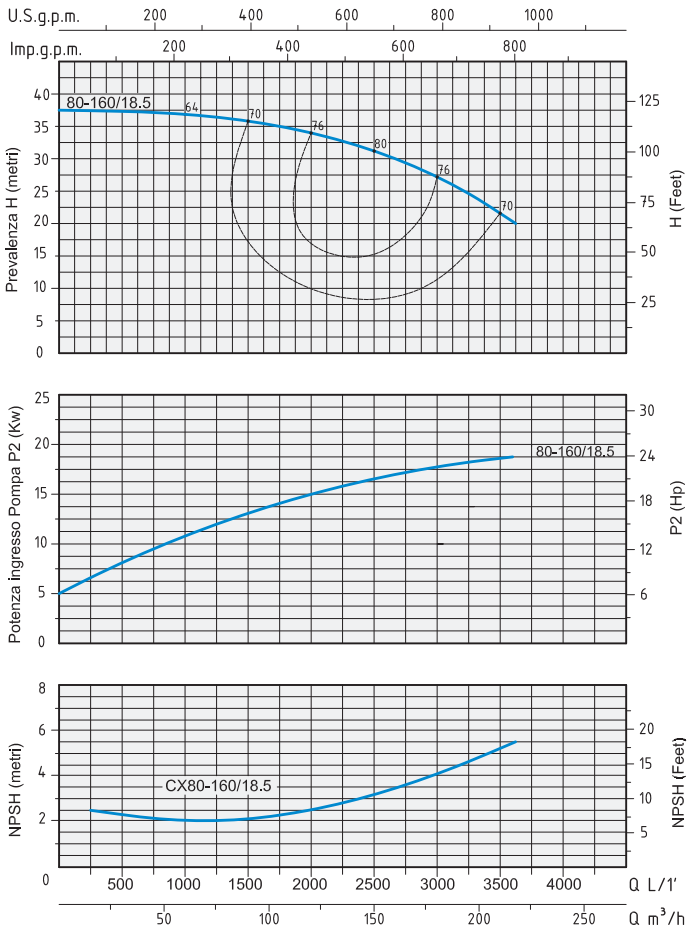

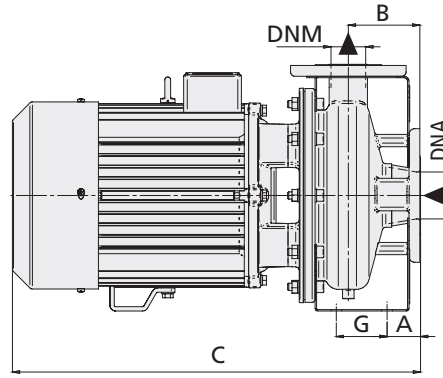
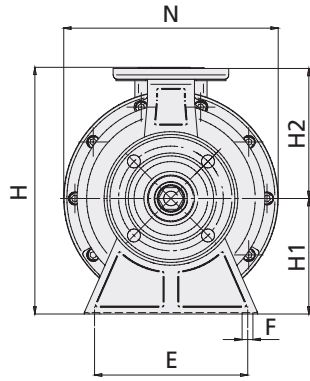

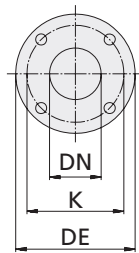

Flange  
Flanges





DIMENSIONI mm - DIMENSIONS mm				
DN	DE	K	Fori - Holes	
			n°	Ø
32	140	100	4	18
40	145	110	4	18
50	165	125	4	18
65	185	145	4	18
80	200	160	8	18
100	220	180	8	18

TIPO TYPE	DIMENSIONI mm - DIMENSIONS mm												DIMENSIONI DIMENSIONS mm			PESO WEIGHT Kg
	A	B	C	E	F	G	H	H1	H2	N	DNA	DNM	P	L	H	
Trifase Three-phase																
CX 32-160/1,5	34	79,5	440	160	15	70	260	112	140	213	50	32	250	475	335	23,1
CX 32-160/2,2	34	79,5	440	160	15	70	260	112	140	213	50	32	250	475	335	26,1
CX 32-200/3	34	82,5	482	212	15	70	346,5	160	186,5	297	50	32	340	620	485	40,7
CX 32-200/4	34	82,5	510	212	15	70	346,5	160	186,5	297	50	32	340	620	485	50,2
CX 32-200/5,5	34	82,5	540	212	15	70	350	160	186,5	297	50	32	340	620	485	67,7

TIPO TYPE	DIMENSIONI mm - DIMENSIONS mm												DIMENSIONI DIMENSIONS mm			PESO WEIGHT Kg
	A	B	C	E	F	G	H	H1	H2	N	DNA	DNM	P	L	H	
Trifase Three-phase																
CX 40-125/2,2	34	79	441	160	15	70	255	112	142	213	65	40	250	475	335	25,6
CX 40-125/3	34	79	478	160	15	70	255	112	142	213	65	40	270	540	430	32,9
CX 40-160/4	34	79	501	160	15	70	280	112	142	230	65	40	270	540	430	37,9
CX 40-200/5,5	46,5	98,5	565	212	15	70	345	160	183,5	297	65	40	340	620	485	62,2
CX 40-200/7,5	46,5	98,5	565	212	15	70	345	160	183,5	297	65	40	340	620	485	66,7
CX 40-200/11	46,5	98,5	705	212	15	70	410	160	183,5	315	65	40	372	805	550	103,3

TIPO TYPE	DIMENSIONI mm - DIMENSIONS mm												DIMENSIONI DIMENSIONS mm 			PESO WEIGHT Kg
	A	B	C	E	F	G	H	H1	H2	N	DNA	DNM	P	L	H	
Trifase Three-phase																
CX 50-125/4	41,5	84,5	520	212	15	70	300	132	164,5	254	65	50	340	620	485	45,2
CX 50-200/7,5	46,5	99	565	212	15	70	350	160	180	297	65	50	340	620	485	66,7
CX 50-200/11	46,5	99	706	212	15	70	410	160	180	315	65	50	372	805	550	102,8
CX 50-200/15	46,5	99	706	212	15	70	410	160	180	315	65	50	372	805	550	111,3
CX 50-200/18,5	46,5	99	751	212	15	70	410	160	180	315	65	50	372	805	550	124,3

TIPO TYPE	DIMENSIONI mm - DIMENSIONS mm												DIMENSIONI DIMENSIONS mm 			PESO WEIGHT Kg
	A	B	C	E	F	G	H	H1	H2	N	DNA	DNM	P	L	H	
Trifase Three-phase																
CX 65-125/7,5	52,5	100	570	212	15	95	350	160	180	283	80	65	340	620	485	63,7
CX 65-160/11	52,5	100	714	212	15	95	410	160	200	315	80	65	372	805	550	103,3
CX 65-160/15	52,5	100	714	212	15	95	410	160	200	315	80	65	372	805	550	112,8
CX 65-200/18,5	52,5	100	760	250	15	95	430	180	225	333	80	65	372	805	550	129,8

TIPO TYPE	DIMENSIONI mm - DIMENSIONS mm												DIMENSIONI DIMENSIONS mm 			PESO WEIGHT Kg
	A	B	C	E	F	G	H	H1	H2	N	DNA	DNM	P	L	H	
Trifase Three-phase																
CX 80-160/11	77,5	125	743	250	15	95	430	180	225	333	100	80	372	805	550	105,3
CX 80-160/15	77,5	125	743	250	15	95	430	180	225	333	100	80	372	805	550	113,8
CX 80-160/18,5	77,5	125	790	250	15	95	430	180	225	333	100	80	395	865	561	125,7
CX 80-200/22	77,5	125	830	280	15	95	445	180	250	360	100	80	395	865	561	188,2